

Mecca Care 25mm Double Towel Grab Rail 600/900mm

Nero

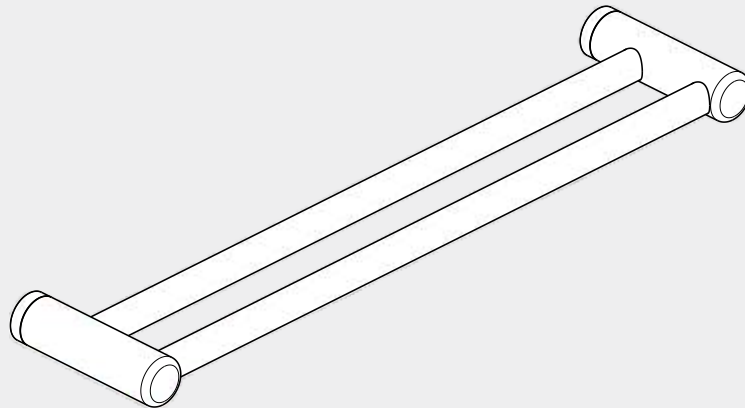

Versions:202506

Drawing

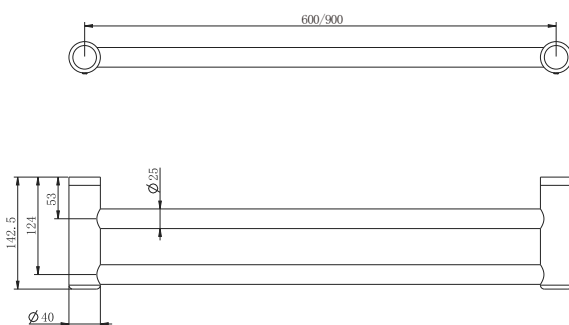







Specifications

600m Length:NR2524d
900m Length:NR2530d

Warning:

These rails are designed to be mounted onto wall studs or masonry walls. Installation is recommended to be completed by qualified trades person who complies with the AS 1428.1-2009 design for access and mobility standard. It is recommended rail location is determined by a qualified occupational therapist or trained professional to the AS 1428.1-2009 standard. Correct installation is required to ensure safe, long term operation. Incorrect mounting can result in reduced capacity of the rail which can result in injury to user and damage to the wall.

Finish

<p> Chrome NR2524dCH NR2530dCH</p>	<p> Gun Metal NR2524dGM NR2530dGM</p>	<p> Brushed Bronze NR2524dBZ NR2530dBZ</p>
<p> Matte Black NR2524dMB NR2530dMB</p>	<p> Brushed Gold NR2524dBG NR2530dBG</p>	<p> Brushed Nickel NR2524dBN NR2530dBN</p>

Features

1. Australian owned and designed.
2. Sizes: 600-900mm Lengths as standard, longer available by request.
3. Modular design, the rail to be mounted horizontally, vertically or at any angle and cut down to suit your bathroom.
4. 100 kg capacity for 25mm double towel rail.
5. 25mm diameter rails are suitable for heavy duty towel rails and smaller hands, in non-DDA bathrooms.
6. Gun metal, brushed gold and brushed bronze colours are PVD coated for long term durability.

*Dimensions are nominal measurements only.

Installation Instruction

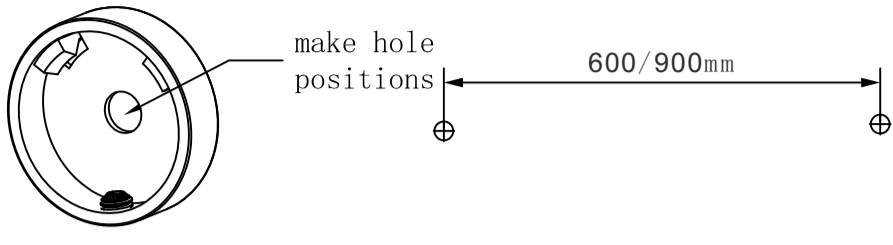
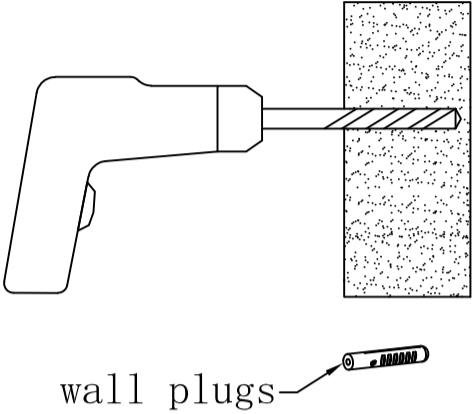
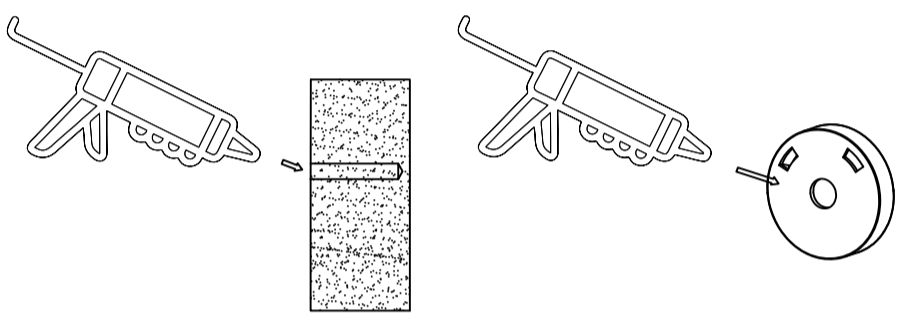
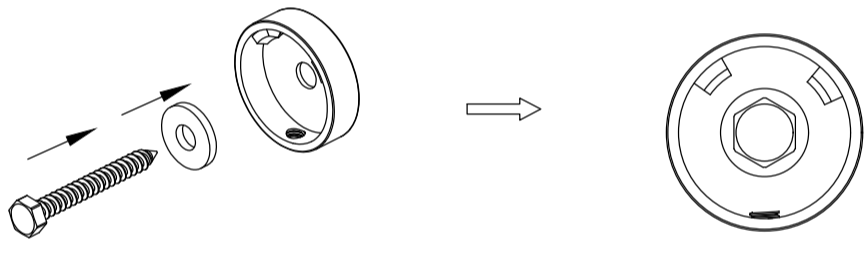
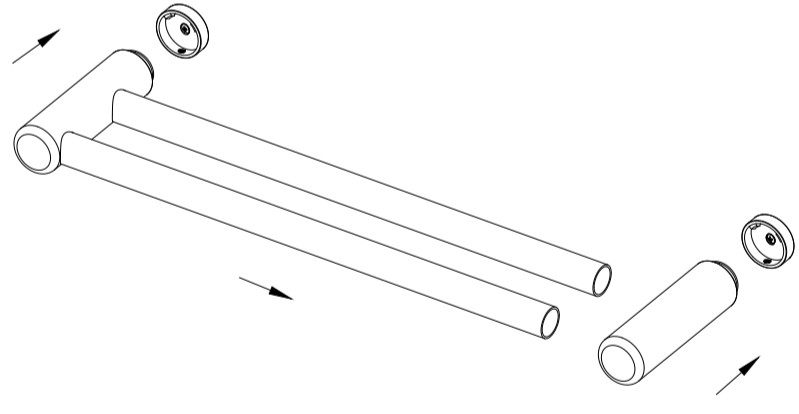
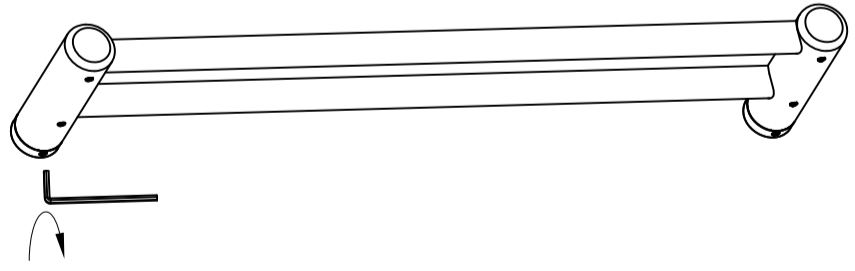
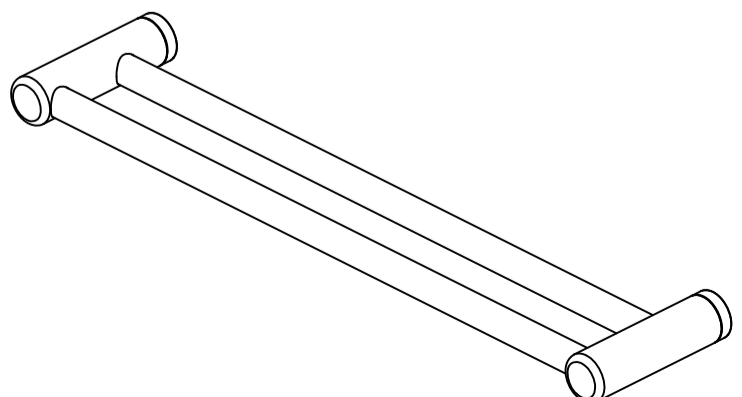
 <p>make hole positions</p> <p>600/900mm</p>	<p>1. Locate wall studs, install into at least one stud. Place wall seal/mounting bracket on wall at correct height over centre of stud and mark hole positions on wall.</p>
 <p>wall plugs</p>	<p>2. Drill pilot holes into wall stud approximately 60mm deep to suit mounting screws (and wall plugs if required).</p> <p>Tip: 4mm hole for screws into timber or 10mm hole for wall plugs.</p>
	<p>3. Apply small amount of silicon to mounting bracket and wall in and around the screw holes.</p>
	<p>4. Put a washer into brackets and install mounting brackets by screwing onto wall.</p> <p>Tip: Use appropriate mounting screws for the wall stud material, supplied screws are for timber wall studs.</p>
	<p>5. Slide rail tube into end bracket and push onto wall brackets.</p> <p>Tip: Rail length can be cut down to a smaller size, simply use an angle grinder, hacksaw or pipe cutter then deburr the end with a file or grinder and reinsert into the end bracket.</p>
	<p>6. Tighten grub screws with Allen key.</p> <p>Tip: If rail rattles, loosen end bracket, twist slightly and tighten.</p>
	<p>7. Finished.</p>

Nero



MECCA CARE
ASSISTED LIVING 25MM

