

130mm Round Tile Insert Floor Waste 100mm Outlet

Nero

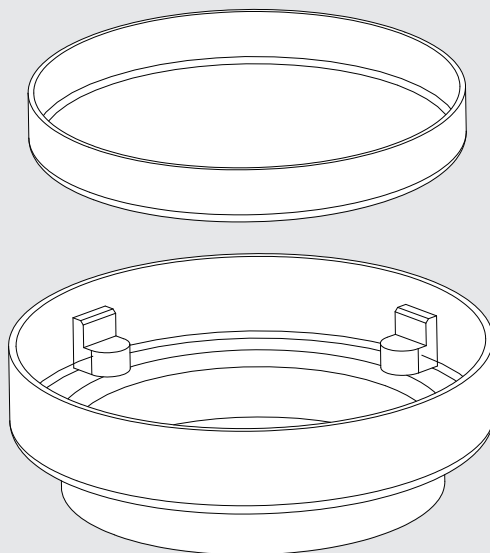

Versions:202506

Drawing

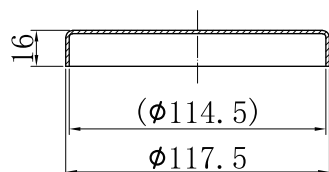
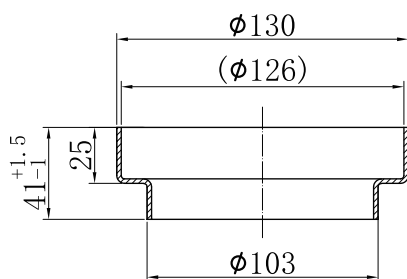







Specifications

SKU
NRFW005
Watermark License
WM-032203

Packaging Includes

1 x floor waste

Finish

- | | | |
|---|--|--|
|  Chrome
NRFW005CH |  Gun Metal
NRFW005GM |  Brushed Bronze
NRFW005BZ |
|  Matte Black
NRFW005MB |  Brushed Gold
NRFW005BG |  Brushed Nickel
NRFW005BN |

*Dimensions are nominal measurements only.

Installation Instruction

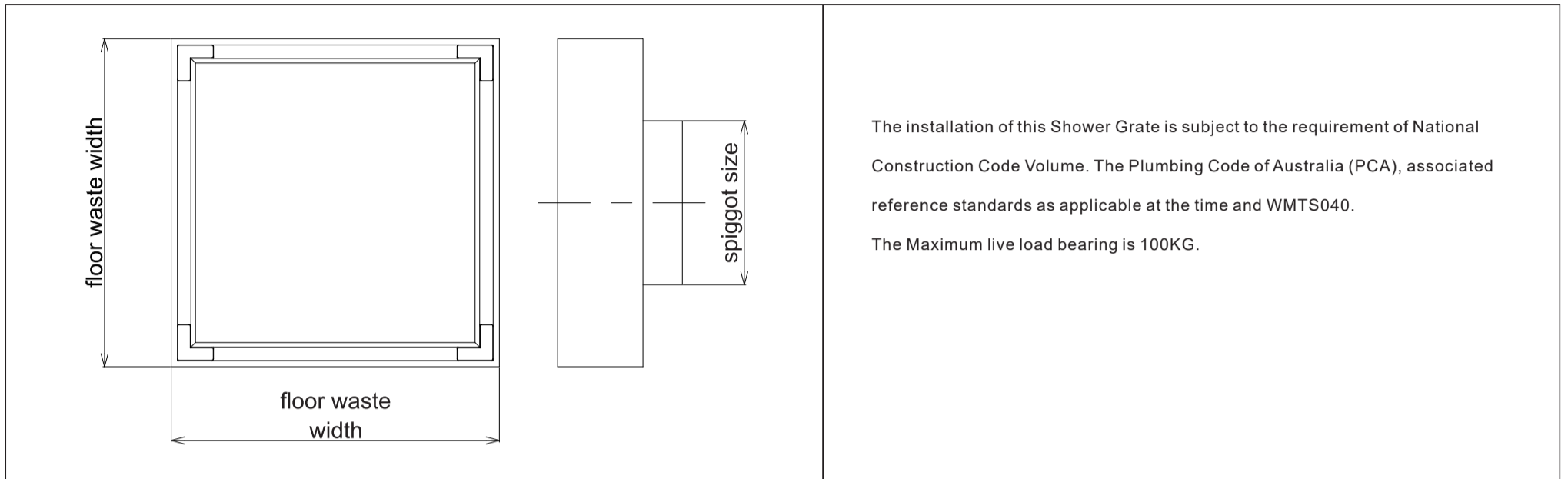

The installation of this Shower Grate is subject to the requirement of National Construction Code Volume. The Plumbing Code of Australia (PCA), associated reference standards as applicable at the time and WMTS040.

The Maximum live load bearing is 100KG.

Floor Waste Width	Spigot Size	Nominal OD Floor Waste Pipe
100mm	50mm	50mm PVC

NOTES:

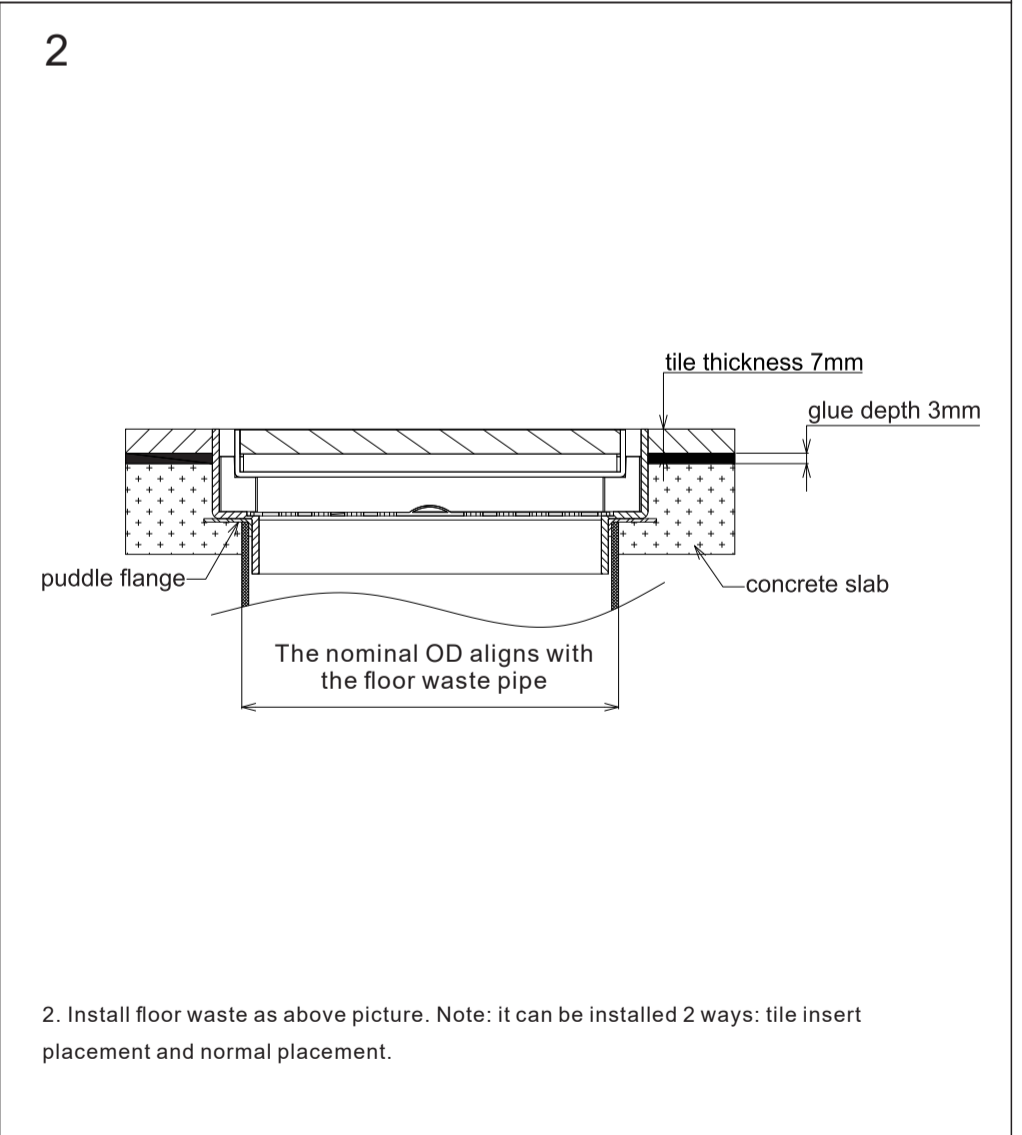
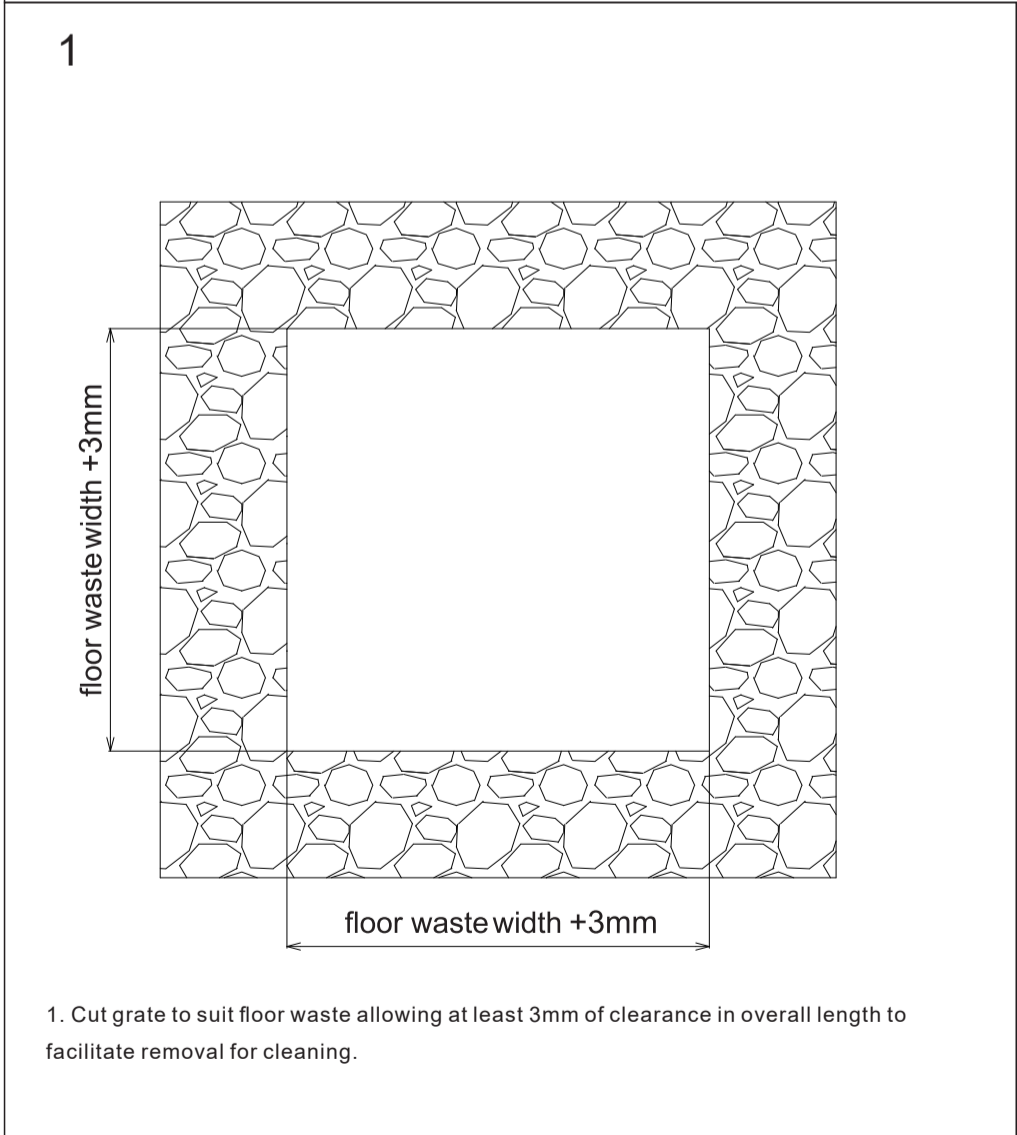
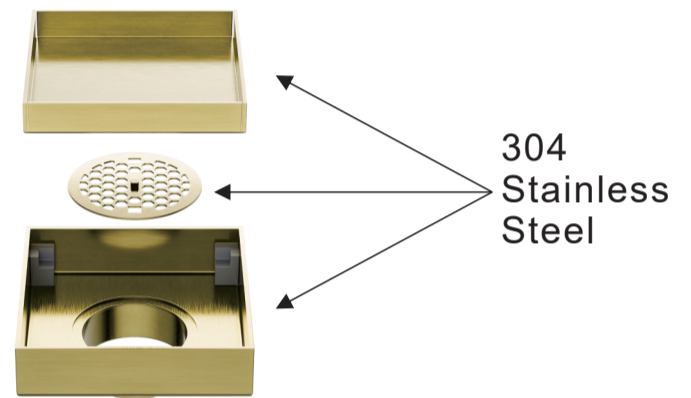

Nero

