

100mm Square Tile Insert Floor Waste 80mm Outlet

Nero

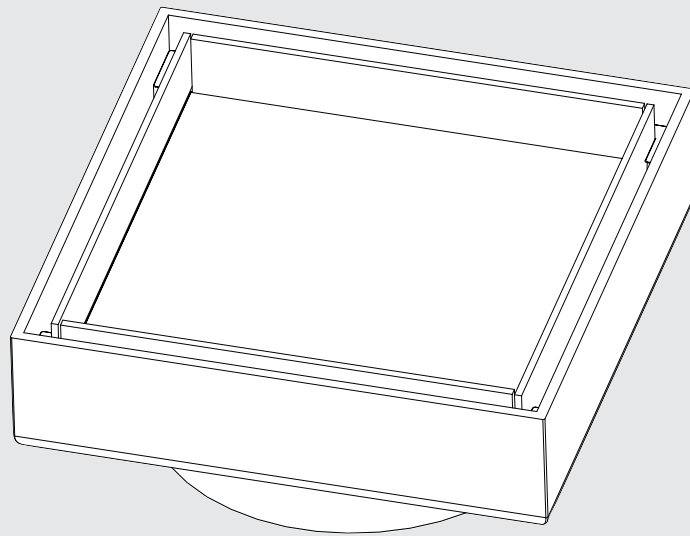

Versions:202506

Drawing

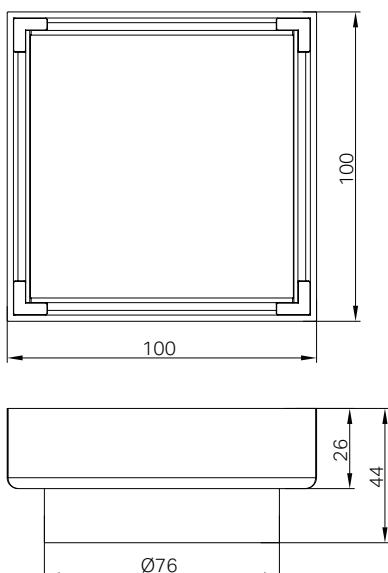





Specifications

Watermark License
WM-032203
Material
304 Stainless Steel

Packaging Includes

1x Floor Waste

Finish & SKU

- | | | |
|--|--|--|
|  Brushed Nickel
NRFW009BN |  Gun Metal
NRFW009GM |  Brushed Bronze
NRFW009BZ |
|  Matte Black
NRFW009MB |  Brushed Gold
NRFW009BG | |

*Dimensions are nominal measurements only.

Installation Instruction

GENERAL INSTRUCTIONS:

- This product must be installed by a licensed plumber. Ensure that your plumbing installation conforms to the Australian/New Zealand Standard AS/NZS 3500.
- Do not pour concrete around floor grate. Always use timber to form the channel for the floor grate and install after the concrete has cured.
- Waterproof membrane to AS3740 should always be between floor and floor grate and the laying of tiles.

MAINTENANCE AND CARE:

- Regularly clean the floor grate / floor waste to maintain proper water flow and prevent blockages.
- Use a soft brush or cloth to gently remove any debris or buildup.
- If the drain outlet becomes clogged, avoid using sharp objects to clear it.
- Instead, use appropriate tools such as a plunger or drain snake to prevent damage to the floor grate.

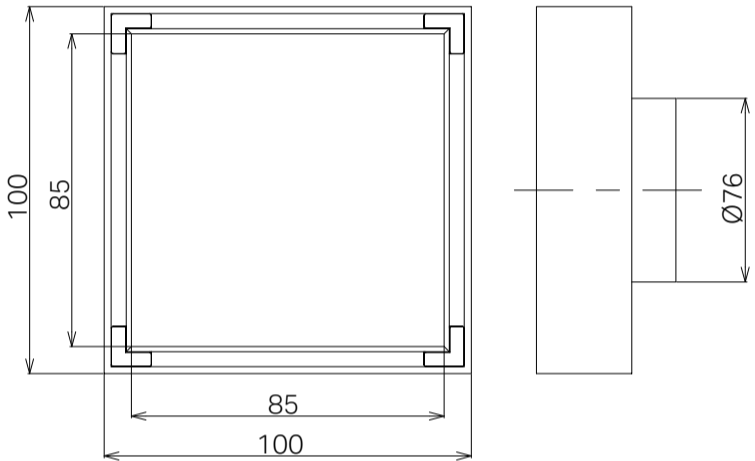

NOTES:

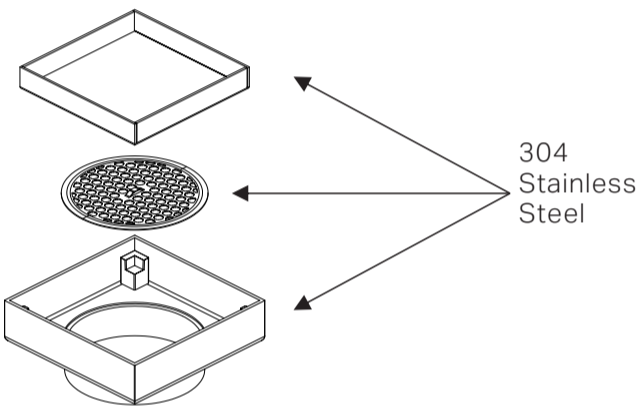

The Maximum live load bearing is 100KG.

Floor Waste Width	DWV Sewer Pipe DN Norminal Size
100mm	80mm

1

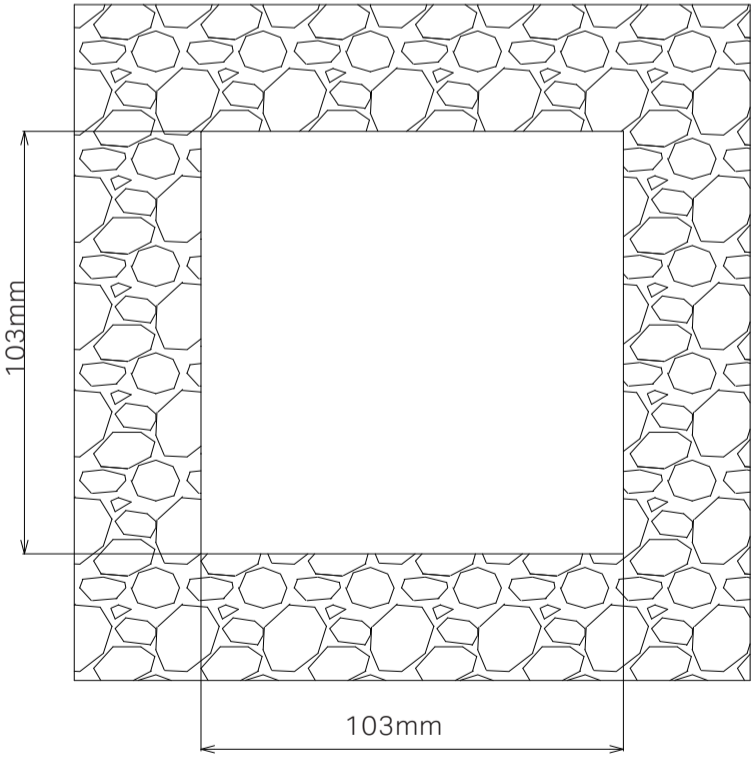

1. Cut grate to suit floor waste allowing at least 3mm of clearance in overall length to facilitate removal for cleaning.

2

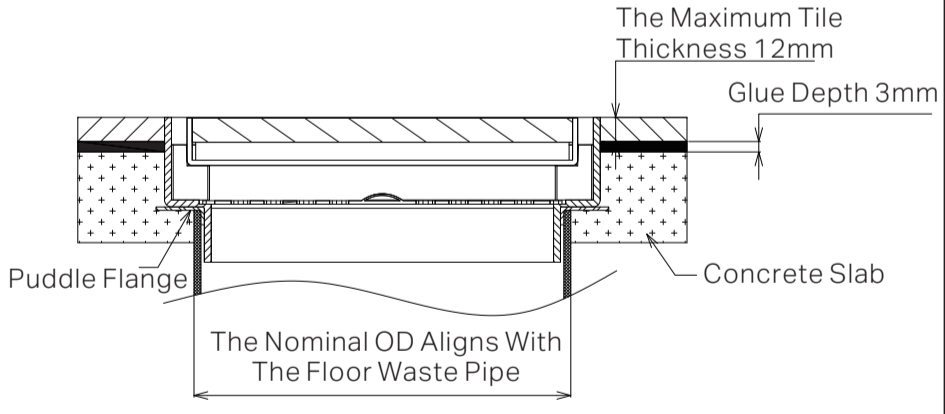

2. Install floor waste as above picture. Note: it can be installed 2 ways: tile insert placement and normal placement. If you choose tile insert placement, the tile size is 82*82mm.

Nero

