

# Zen SS316L Toilet Roll Holder

Nero

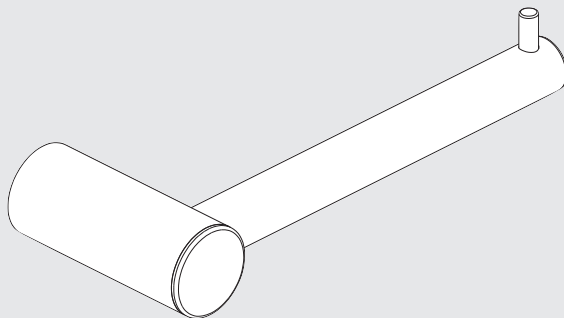

Versions:202506



Warranty Policy

## Drawing

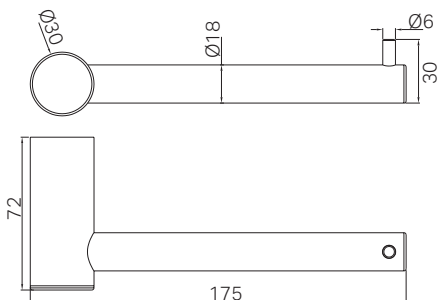

## Features

- 316L grade stainless steel construction for durability
- Can be installed left or right
- Easy to install

## Packaging Includes

- 1x Toilet Roll Holder
- 1x Fixing Kit

## Finish & SKU

 **Brushed Bronze**  
NR1686BZ

 **Graphite**  
NR1686GR

 **Brushed Gold**  
NR1686BG

 **Brushed Nickel**  
NR1686BN

\*Dimensions are nominal measurements only.

## GENERAL INSTRUCTIONS AND WARNINGS

- Before installation, make sure the wall surface is clean and dry to ensure a secure attachment.
- When tightening screws, do not apply excessive force to prevent damage to the wall or the fixtures.
- Use the correct tools: a drill with a 6mm bit, screwdriver, and level.
- Wear appropriate safety gear, such as gloves and safety glasses, to protect yourself during installation.
- Before drilling, check the wall for any hidden pipes or electrical wires to avoid accidental damage.
- Ensure all measurements are accurate before drilling holes to prevent misalignment of the accessories.

## MAINTENANCE AND CARE

- Clean the accessories with a soft, damp cloth. Avoid using abrasive cleaners, which can damage the finish.

# Toilet Roll Holder Installation (Right Hand)

**Note:** Our toilet paper holder is designed for versatility, allowing the rod to be installed with either left-hand or right-hand opening.

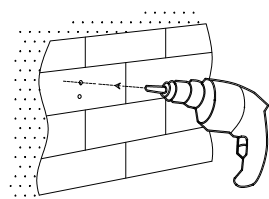
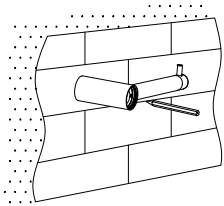

1. Unscrew the cover from the toilet roll holder. Place the toilet paper holder in the desired installation position as shown. Mark the center of the mounting bracket through the support with a marking pen.

2. Use an electric drill with a 6mm drill bit to drill holes at the marked points.

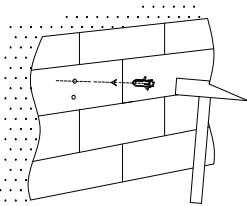

3. Insert the expansion plugs into the drilled holes using a hammer.

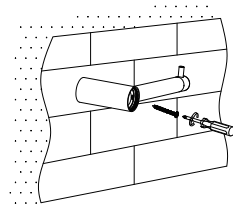

4. Drill the expansion screws into the pre-drilled holes.

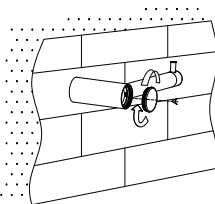

5. Screw on the cover of the toilet roll holder.

# Toilet Roll Holder Installation (Left Hand)

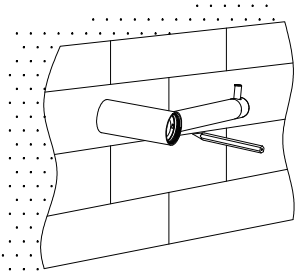

1. Unscrew the cover from the toilet roll holder. Place the toilet paper holder in the desired installation position as shown. Mark the center of the mounting bracket through the support with a marking pen.

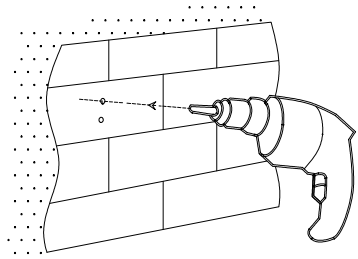

2. Use an electric drill with a 6mm drill bit to drill holes at the marked points.

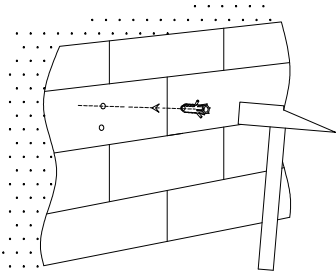

3. Insert the expansion plugs into the drilled holes using a hammer.

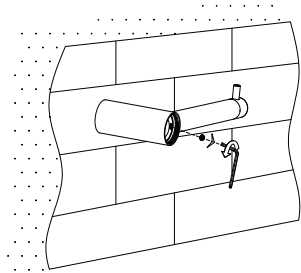

4. Remove the rod of the toilet roll holder by unscrewing the grub screw.

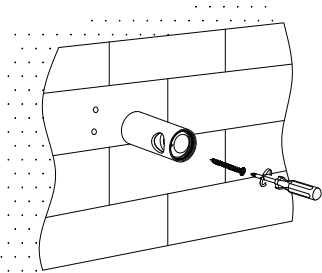

5. Position the rod bracket hole to the left and secure the bracket with expansion screws, as shown in the image.

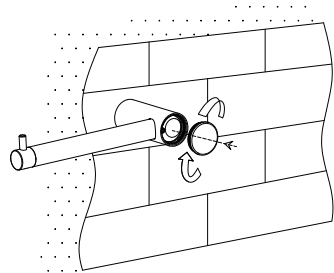

6. Install the rod of the toilet roll holder by tightening the grub screw, and screw on the cap.